



WEIGHING FROM A to ZWIEBEL

ZWIEBEL - THE STAMP OF QUALITY

At Zwiebel, quality knows no compromise !
Our COFRAC 17025 accreditation, ISO 9001 certification and quality service are a sure guarantee that every stage of manufacture is strictly respected and our weights and masses are in conformity.



ZWIEBEL CONTENTS

TOTALLY CONTROLLED MANUFACTURING	4
TRACEABILITY MEANS SECURITY	6
CALIBRATION & SERVICES	8
QUALITY + - E & F	10
WEIGHTS - F & M	12
TAILORED PRODUCTION	13
INDUSTRIAL MASSES - F & M	14
ANTI-VIBRATION SUPPORTS	16
TECHNICAL DATA	17
LEGAL METROLOGY - M	18
OUR SCALES	19



CONNECT ONLINE !

On Zwiebel's comprehensive website, you will find plenty of information on our company and products : news, technical data, sales brochures, ISO certificates etc.





ZWIEBEL - YOUR PARTNER

Two centuries of experience have forged our know-how at Zwiebel, and today we rank as the top European manufacturer of precision weights and masses.

Zwiebel is present in every market sector. Our state-of-the-art expertise and innovation capacity mean we can meet all types of requests from 0.1 mg to 2 tonnes in every class of precision (E0 to M3).

Today, our products are marketed to myriad customers across the industrial sectors, including aeronautics, the food industry, chemicals and pharmaceuticals both in France and across the world. Furthermore, we supply leading references of international renown.

Zwiebel also works with a network of distributors ensuring a dynamic, growing presence in a broad range of countries.

We take part in research on defining new materials and we research and develop new automation equipment for calibration.

We are also the first manufacturer to meet normative requirements and the only one to integrate all the stages of manufacturing on our premises - from the selection of raw materials to transport.



MADE IN FRANCE

All our products are designed and assembled in our factory in France – a real guarantee of quality.



TOTAL CONTROL OF THE **MANUFACTURING** PROCESS



METICULOUS SELECTION OF RAW MATERIALS

At Zwiebel, our experience and expertise is reflected in our partner-suppliers who share our exacting requirements. The common point they share is precise, stringent specifications for top-quality products. We take

particular care in selecting our raw materials and conduct quality control on reception before supplying our production workshops.

HIGH-PERFORMANCE MACHINING PROCESS

The machining workshop manufactures each weight in conformity with technical specifications approved by the methods department. The aim is to approach the tolerances required before adjusting the weight. The process relies on high-precision CNC machines combining optimum mechanics and robotics.

A SPLASH OF COLOUR

To provide the very best service, Zwiebel focuses on the paint quality and offers a

range of colours to meet our users' many needs. All our cast iron masses are painted in a dedicated workshop providing a flawless finish.



Painting+ operation on a mass of 1 tonne



POLISHING
FOR A FLAWLESSLY SMOOTH SURFACE



As proof of our industrial expertise, all our weights are polished by automated equipment and then finished by hand. This technique means we obtain a mirror-polish surface optimising the use, quality and precision of our masses. Another advantage – polishing means shiny, anti-adhesive surfaces.

ADJUSTMENT
ULTIMATE ACCURACY

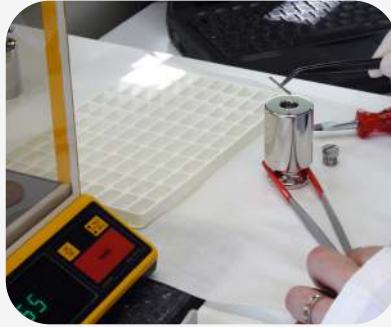

At Zwiebel, we have adjustment techniques down to a fine art. The aim is to provide total accuracy for each weight. For this, we use two processes: adding material (stainless steel wires) when the weight has an adjusting cavity, and removing material (abrasion) in the case of a monobloc weight. This is high-precision work – especially for weights under 1 gram.

FROM STANDARD
TO TAILORED PACKAGING



We make full use of our experience to offer packaging solutions adapted to the requirements and constraints of our customers. Our varied range includes plastic or wooden packaging for standard or made-to-measure weights and masses crafted by our in-house department.

WORLDWIDE DELIVERIES

All Zwiebel products are transported via a network of French and international carriers. Daily flows guarantee optimised delivery deadlines in every continent. Packaging solutions are devised to carry our products in all safety using reinforced cardboard boxes and pallets, as appropriate.



Composition example:
plastic case set 6111.11g F1

A WHOLE RANGE OF MATERIALS

Offering quality products through a quality service – that's the key to our philosophy at Zwiebel. This approach is evident in our choice of materials, selected in agreement with our customers. We propose weights in quality+ stainless steel, brass and cast iron according to our customers' requirements.

STAINLESS STEEL	CAST IRON	BRASS
8,0 kg/dm ³	7,2 kg/dm ³	8,4 kg/dm ³





OUR EXPERIENCE **MAKES ALL THE DIFFERENCE**

TRACEABILITY MEANS SECURITY



THE GUARANTEE OF EXCELLENT SERVICE

In our laboratories, we use precision equipment and stringent methods and employ skilled personnel to calibrate the weights. With an extremely fine resolution – from 0.1 microgram to 1 gram –

the manual comparators and automated systems we use are the guarantee of excellent service.

A RENOWNED AND ACKNOWLEDGED RANGE

Our weights and masses meet the requirements of the international OIML recommendation R111 (International Organisation of Legal Metrology).

Since 1991, Zwiebel has been accredited by the French Accreditation Committee, COFRAC*, which today is acknowledged on the international market.

This accreditation means we can deliver calibration certificates.

We have reinforced this approach through on-going audits and cross-comparisons which

guarantee the high precision and quality of the weights and masses produced by the Zwiebel metrology laboratory.

* COFRAC calibration certificates are recognised in all countries signing the EA agreement (European Cooperation for Accreditation).

www.european-accreditation.org



cofrac



ETALONNAGE

MASS
ACCREDITATION
2.1218
Scope available
on www.cofrac.fr

100% ZWIEBEL SOFTWARE



ZWIEBEL designs specific software to control technical data and ensure the traceability of the calibration record of a weight. Developed through on-going interaction between the technical departments, laboratories and sales teams, the software reflect the flexibility and rapid reactions of our customer-oriented organisation.

TRACEABILITY AN EXACTING REQUIREMENT

To meet and guarantee traceability requirements according to Quality Assurance standards, each weight from 1g upwards carries its own identification. This identification is unique and indelible so the weight's entire record can be traced and tracked (calibrations, material, interventions). It eliminates all risk of error

linked with weight permutation or its use with an inappropriate calibration certificate. By recording identification in calibration documents, the calibration data can be associated with the weight concerned without any ambiguity.

ENGRAVING – A COMPETITIVE EDGE

All our products are engraved by diamond point or laser. This service is unique on the market and is part and parcel of our traceability and quality assurance policy.



For ZWIEBEL — Z X 00X

Year of manufacture

Number incremented by the nominal mass



AN ACTIVE PRESENCE ON THE INTERNATIONAL SCENE

As a privileged partner in mass metrology, we have a universal clientele. Among them, the BIPM (International Bureau of Weights and Measures) and many national or primary laboratories that are true benchmarks in each country.



CALIBRATION SERVICE + RECALIBRATION AND REPAIRS



A FULL PANOPLY OF SERVICES

From calibration to adjustment, not forgetting repairs, Zwiebel offers a whole panoply of services. The sales department is at the service of each

customer. Customer needs are consigned to a reception sheet and monitoring of the order is personalised (advice, assistance, replacement offers). Our sales teams provide feedback on the progress of our interventions.

VERY LONG-LIFE ASSISTANCE

We ensure the maintenance of weights and masses over time. Indeed, by recalibrating your weights in our laboratories, you can control developments and, if need be, request the "manufacturer" to adjust or repair them. Repairs to the weights (adjusting, painting, polishing, shot-blasting, degreasing etc.) guarantee the calibration

service and a long useful life. Calibration documents are available in English, German, Italian, Portuguese and Spanish.





OPTIMISING YOUR DEADLINES

You can **schedule** dispatch, calibration and return dates with our sales department (reconfirming your order if necessary).

If appropriate, **indicate** the number of the last ZWIEBEL calibration certificate to obtain an identical service.

Specify the shape, material, constitution, values, quantities, the state of the weights and masses and the services you require.



SENDING YOUR PRODUCTS GUIDE

Use the original boxes or packaging. Do not underestimate the weight of the equipment during transport. We advise you to check that the products are firmly packed and to place the heaviest weights at the bottom of your package. You should use shock-resistant packaging.

The equipment must arrive clean and, if appropriate, decontaminated at our delivery address.

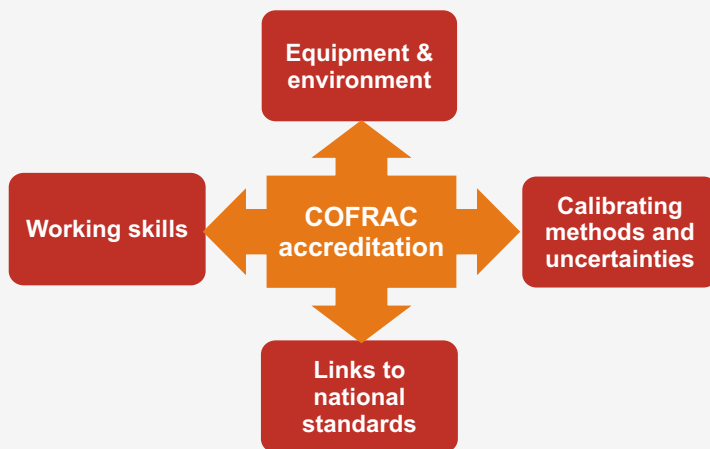

WHAT DOES ACCREDITATION IMPLY? NF EN ISO/CEI 17025

Accreditation is an acknowledgement that a laboratory conducts calibration in a defined field with specified uncertainties.



HANDLING – GUIDE

Handling the weights requires some precautions. Using our fine brushes, remove the dust from your weights after each use. Never handle the weights with bare hands. Always wear protective gloves and equip yourself with tweezers and handles. Don't forget to use our cases and boxes to store your weights correctly.

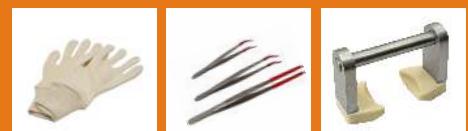



DISCOVER THE WORLD OF **QUALITY+**



BEYOND REGULATIONS

Perfect density, superior quality stainless steel, optimum magnetic susceptibility and greater resistance to wear: the Quality+ solution underscores Zwiebel's expertise and constitutes a top-of-the-range answer to the criteria laid down by the International Organisation of Legal Metrology. A true market pioneer,

Zwiebel is developing solutions which go beyond the regulations.



Quality +

EXPERT IN SCIENTIFIC METROLOGY

Proving its commitment to all markets, Zwiebel can meet all requirements in all classes of metrology. From E0 to F1, we have developed a full range in scientific metrology. E1 class weights ensure the traceability between national standards and weights of lower accuracy classes. E2 class weights are used to calibrate weights of lower accuracy classes and are used with class I weighing

instruments. All these weights must be delivered with a calibration certificate guaranteeing traceability. Zwiebel also produces a full spectrum of cobalt alloy wires reputed for their reliability and long life. Materials, shapes and finishes - Zwiebel quality knows no bounds.



Composition example: wooden box set totalising 1111.11g E2 and individual weight of 100g.

**TAKING ULTRA-PRECISION
ALL THE WAY**

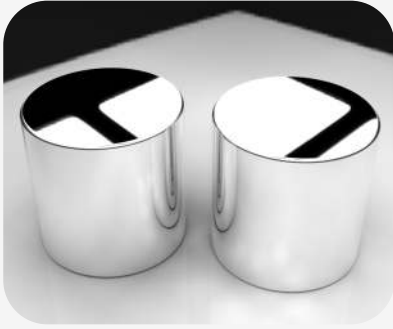

Experience is the baseline enabling Zwiebel to offer a broad choice of weights and masses. We are therefore able to go further in ultra-precision by proposing products superior to quality E1 – sound proof of our tried-and-tested expertise.

A BENCHMARK



Acknowledged for the quality of our solutions in scientific metrology, Zwiebel has been selected as a benchmark by national metrology laboratories both in France and abroad. Our expertise extends to a variety of sectors from state-of-the-art to more traditional industries, not forgetting research and measure and control laboratories.

**TOP OF THE RANGE
ALL DOWN THE LINE**

Zwiebel proposes F1 class weights in the Quality+ version. This means top-of-the range for the whole spectrum of scientific metrology. Up to 20g, these F1 weights are monobloc. Above this value, they have an adjustment cavity. The F1 class is used for calibrating weights of lower accuracy classes and with class I and II weighing instruments. They can also be used as control weights and usually come with a calibration certificate.

YOUR WEIGHTS IN A SAFE PLACE

Type E and F weights can be supplied individually or as a set, in a plastic case or a wooden box. Quality wood, velvet trim and meticulous finishes provide a professional touch to the overall look.

3 shapes of wire are proposed : triangular, square and pentagonal, each one corresponding to a nominal mass.



Tweezers, gloves and fine brushes: Zwiebel has developed a range of appropriate accessories to handle the weights. An extended, coordinated range of tools bearing witness to Zwiebel's tradition of innovation.





EXPERTISE AT EVERY LEVEL



QUALITY GOES HAND-IN-HAND WITH COMPETITIVE EDGE

From class F1 to class M2, Zwiebel combines high quality and competitive edge. Stainless steel for class F1 to M1 weights, brass for M2 class weights: the range conforms to the recommen-

dations of the OIML. Aluminium leaf weights from 1 mg to 500 mg make up the Zwiebel product line.

THE WHOLE WEIGHING SPECTRUM

Class F1 to M2 weights are designed to calibrate masses of a lower accuracy class and be used with class II and III weighing instruments. Zwiebel therefore proposes a particularly broad range reflecting a know-how accumulated over decades.

PERFORMANCE AND RELIABILITY

The Zwiebel range also includes a set of hanging masses and hook-fitted masses. The applications are countless: pressure measurement, torque measurement, resistance and traction tests,

dynamometric power. The base is made of stainless steel or brass. The adjustment and calibration of each mass and their individual identification are a sure guarantee of performance and reliability.



Example of composition: wooden box set totalising 611.11g F1

TAILOR-MADE

FROM DESIGN TO THE FINISHED PRODUCT

INDIVIDUALISED ATTENTION FOR EACH REQUEST

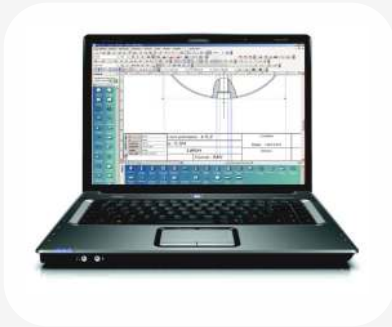

At Zwiebel, we work hand-in-hand with our customers to define, design and produce specific weights and masses. Special products designed using CAD-CAM and visual 2D or 3D systems. Combining this expertise and technical resources means we can study all types of projects and find solutions for our customers' exacting processes.

PERSONALISATION - A KEYWORD



To meet customer needs in terms of value, space, use and handling, we can design weights with specific characteristics. Whether in terms of material: brass, aluminium, stainless steel, steel, cast iron, plastic - or shape: monobloc, with adjusting cavity, cylindrical, cubic etc. There is also a wide variety of finishes: mirror polish, brushed, painted, surface coated. We propose weights of all tolerances conforming to OIML classes and specific tolerances. Other personalised solutions: laser marking, diamond engraving, painted reference marks. Finally, we have developed a range of accessories adapted to the needs of our customers: table, handling system, protection devices and packing.

A SPECIFIC COMPETENCE : PACKAGING

Zwiebel applies a specific know-how in this field : designing special cases. Tailor-made packaging for weights and all other laboratory equipment. Our approach spans many processes: tailored cut-outs, personalisation through milling logos or specific motifs, creation of additional receptacles in our standard cases. We design and produce individual units or small or medium batches, in different sizes according to our customers' needs. A sure way to protect and enhance our customers' equipment.

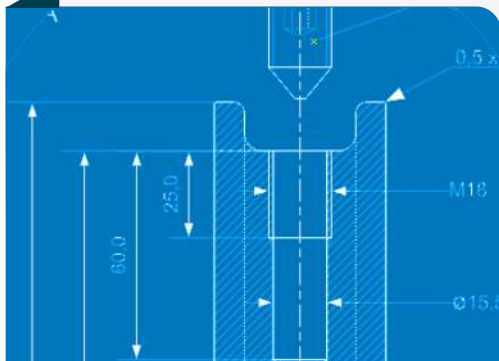

THE CONTRIBUTION OF OUR RESEARCH TEAMS

Zwiebel is backed by a research laboratory and a machining workshop to develop measurement know-how. Each project is studied in depth to find the optimum solutions at the best prices and shortest deadlines. Our teams make full use of a whole series of technical resources: CAD-CAM software, 3-D models and CNC machines.



Painting +

HIGH-PERFORMANCE MASSES FOR INDUSTRY



VARIATIONS ON THE THEME OF INDUSTRIAL MASSES

From 5 kg to 2 tonnes, Zwiebel has designed a whole range of industrial masses with myriad variations: stainless steel or cast

iron, F1, F2, M1, M2, or M3 classes, with or without feet depending on nominal masses, stackable or not. We also propose a broad range of colours. Ultra-compact, practical and easy to handle, the heaviest masses can be handled by forklift trucks or slings. We make the difference in that we take on board the customer's specifications way upstream in order to build a personalised solution together.

masses by accumulating parallelepiped weights of 5, 10 or 20 kg. They can be handled by forklift trucks or slings and are favourable for linear measurements. A tailor-made solution adapted to all control requirements: pallet scales, ground scales etc. Our baskets are adjusted and calibrated.

A COMPLETE SET OF STANDARD MASSES

Zwiebel also proposes calibrated weight baskets. Made of stainless steel, they allow you to obtain a broad scale of

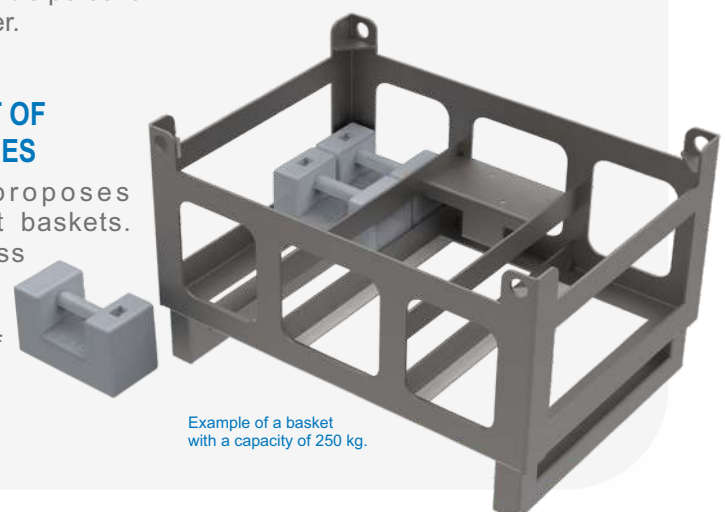

Example of a basket with a capacity of 250 kg.

**PARALLELEPIPED WEIGHTS
IN STAINLESS STEEL AND
CAST IRON**



Weights ranging from 5 to 50 kg designed to verify or calibrate class M2 weights and be used with class III weighing instruments (medium accuracy). The cast iron weights are delivered painted grey in the standard version, but we offer our customers the possibility of personalising them through a wide choice of colours. Stainless steel is recommended in the food industry, pharmaceuticals, chemicals and similar industries.

**PAINTING+ -
NOTHING BUT PLUS POINTS !**



The Painting+ service has been set up to meet quality and durability requirements. Our solutions foster resistance to corrosion, a longer life and greater resistance to extreme conditions. They also ensure extra protection through passivation. Painting+ can be applied to all weights from 5 kg to 2 tonnes.

**DID YOU KNOW...
MASSES FOR CONTROL
AND TEST**

In addition to metrology, Zwiebel is diversifying its range by offering control and test masses from 100 to 2000 kg with a tolerance of +/- 5%.

These masses and mainly designed to check safety equipment such as lifts, hoists, travelling cranes, trolleys and tailgate lifts etc.



HANDLING – GUIDE

Use our slings to handle masses ranging from 100 kg to 2 tonnes. Don't forget to use cotton or leather gloves especially when handling parallelepiped weights.

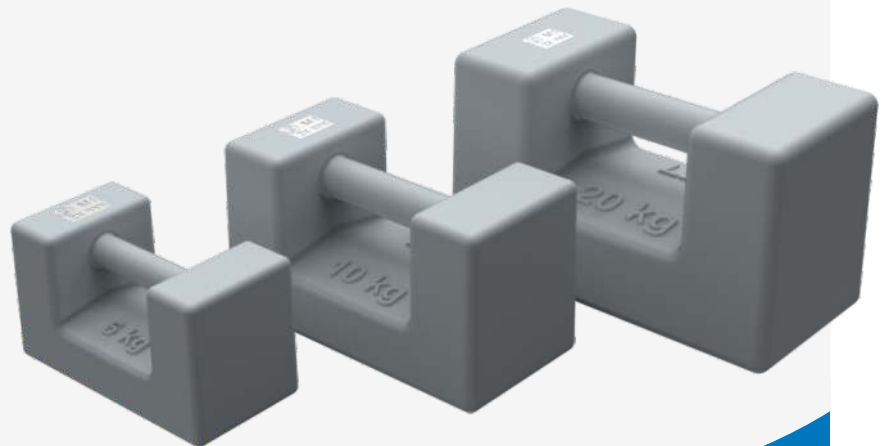

IN EVERY FIELD

From petrochemicals to the mechanical industry, from the food industry to chemicals and pharmaceuticals, Zwiebel offers a range of solutions for every industrial need. A made-to-measure approach both in terms of designing weights and masses and also in terms of advice, training and logistics.



BASES DESIGNED FOR THE QUALITY OF YOUR MEASUREMENTS



FIXED OR MOBILE?

We adapt our bases to suit our customer's needs and facilities. We propose mobile bases combining a granite base with an aluminium structure. Adjustable feet ensure stability and level

adjustment. Tailored solutions integrating our customers' constraints and requirements.

AIM: STABILITY

Made entirely of granite, the anti-vibration tables and bases are designed to optimise the quality of our customers' measurements. Designed more specifically for

laboratories and metrology rooms, they offer a number of advantages : maximum resistance to wear due to the extreme robustness of the material, an anti-vibration effect accentuated by the use of perfectly positioned studs, and stability and level adjustment ensured by adjustable feet.



TECHNICAL DATA

MAXIMUM ERROR TOLERATED ($\pm \delta m$ in mg)

IN COMPLIANCE WITH OIML R111

Nominal value	Class E1	Class E2	Class F1	Class F2	Class M1	Class M1-2	Class M2	Class M2-3	Class M3
1 mg	0,003	0,006	0,02	0,06	0,2				
2 mg	0,003	0,006	0,02	0,06	0,2				
5 mg	0,003	0,006	0,02	0,06	0,2				
10 mg	0,003	0,008	0,025	0,08	0,25				
20 mg	0,003	0,01	0,03	0,1	0,3				
50 mg	0,004	0,012	0,04	0,12	0,4				
100 mg	0,005	0,016	0,05	0,16	0,5		1,6		
200 mg	0,006	0,02	0,06	0,2	0,6		2,0		
500 mg	0,008	0,025	0,08	0,25	0,8		2,5		
1 g	0,010	0,03	0,10	0,3	1,0		3,0		10
2 g	0,012	0,04	0,12	0,4	1,2		4,0		12
5 g	0,016	0,05	0,16	0,5	1,6		5,0		16
10 g	0,020	0,06	0,20	0,6	2,0		6,0		20
20 g	0,025	0,08	0,25	0,8	2,5		8,0		25
50 g	0,030	0,10	0,3	1,0	3,0		10		30
100 g	0,05	0,16	0,5	1,6	5,0		16		50
200 g	0,10	0,3	1,0	3,0	10		30		100
500 g	0,25	0,8	2,5	8,0	25		80		250
1 kg	0,5	1,6	5,0	16	50		160		500
2 kg	1,0	3,0	10	30	100		300		1 000
5 kg	2,5	8,0	25	80	250		800		2 500
10 kg	5,0	16	50	160	500		1 600		5 000
20 kg	10	30	100	300	1 000		3 000		10 000
50 kg	25	80	250	800	2 500	5 000	8 000	16 000	25 000
100 kg		160	500	1 600	5 000	10 000	16 000	30 000	50 000
200 kg		300	1 000	3 000	10 000	20 000	30 000	60 000	100 000
500 kg		800	2 500	8 000	25 000	50 000	80 000	160 000	250 000
1 000 kg		1 600	5 000	16 000	50 000	100 000	160 000	300 000	500 000
2 000 kg			10 000	30 000	100 000	200 000	300 000	600 000	1 000 000
5 000 kg			25 000	80 000	250 000	500 000	800 000	1 600	2 500 000

MAGNETISM CHARACTERISTICS

Class	Permanent magnetism $\mu\text{OM}(\mu\text{T})$	Susceptible magnetism χ		
		$m \leq 1 \text{ g}$	$2 \text{ g} \leq m \leq 10 \text{ g}$	$20 \text{ g} \leq m$
E1	< 2,5	< 0,25	< 0,06	< 0,02
E2	< 8	< 0,9	< 0,18	< 0,07
F1	< 25	< 10	< 0,7	< 0,2
F2	< 80		< 4	< 0,8
M1	< 250			
M1-2	< 500			
M2	< 800			
M2-3	< 1 600			
M3	< 2 500			

MASS DENSITIES OF MATERIALS

Material	Mass density in kg/m^3	Uncertainty in kg/m^3 $U(k=2)$
Steel	7 700	± 200
Aluminium	2 700	± 130
Cast iron	7 100	± 600
Brass	8 400	± 170
Stainless steel	7 950	± 140



AUSTRIA BMWA	GERMANY DAkKS	NORWAY NA
BELGIUM BELAC	GREECE ESYD	POLAND PCA
BULGARIA BAS	HUNGARY NAT	ROMANIA RENAR
CROATIA HAA	IRELAND INAB	PORTUGAL IPAC
CZECH REPUBLIC CAI	ITALY SIT	SLOVENIA SA
DENMARK DANAK	LATVIA LATAK	SLOVAKIA SNAS
ESTONIA EAK	LITHUANIA LA	SPAIN ENAC
FINLAND FINAS	NETHERLANDS RVA	SWEDEN SWEDAC
FRANCE COFRAC	LUXEMBURG OLAS	SWITZERLAND SAS
MACEDONIA IARM	MALTA NAB-MALTA	TURKEY TURKAK
		UNITED KINGDOM UKAS

M



WORLDWIDE OFFER IN LEGAL METROLOGY AND EDUCATIONAL EQUIPMENT



RESPECTING THE REGULATIONS

At the spearhead of scientific metrology, Zwiebel also proposes weights for legal metrology from 1 mg to 50 kg. These products are used to carry out commercial transactions in conformity with the regulations in force. They conform

to the requirements of OIML recommendation R111.

Our range of legal metrology cannot be supplied with a COFRAC calibration certificate.

ACKNOWLEDGED ACCREDITATION

Legal metrology weights are designed to be used for initial legal verification. They are delivered with the regulatory verification marks. As an acknowledged expert in the field of control and measurement, Zwiebel is authorised to hallmark weights. This accreditation is a further example of Zwiebel's solid reputation.

BY UNIT OR BY CASE

We propose M1 and M2 class weights as individual units or in sets, in wooden boxes or on a

base. Shapes vary from cylindrical versions to old models. These weights are also used in the field of school education (in this case they are delivered without verification markings).



ELECTRONIC & ROBBERVAL SCALES

In partnership with a well-known manufacturer, Zwiebel supplies a broad range of precision, portable and industrial scales on request.

PORTABLE SCALES



Zwiebel offers a practical, compact and versatile range. The scales are battery or mains operated.

PRECISION SCALES



We propose a full array to answer all measurement and control needs in laboratories.

INDUSTRIAL SCALES



Industrial performance at a competitive price: at Zwiebel, our expertise is underscored by developing a range of platforms and display systems adapted to the environment of our customers.

ENVIRONMENT FRIENDLY

For sustainable development purposes, we propose scales that can operate without batteries or electricity. These products, assembled in our workshops, combine energy savings, reliability and robustness.

ROBERVAL SCALES

Zwiebel manufactures and sells a range of 14 models covering all types of weighing up to 20 kg. The range includes different pan concepts so the scales are adapted to every trade. Mechanical operation does not require any particular maintenance. The products look simple, but are the fruit of in-depth design and extensive know-how.



DID YOU KNOW...

We supply pans of diameter 130 to 300 mm separately.



POSTAL ADDRESS

ZWIEBEL
SAINT JEAN SAVERNE
BP 50002
F-67701 SAVERNE CEDEX

DELIVERY ADDRESS

ZWIEBEL
20 Grand Rue
Dépôt n°1
F-67700 SAINT JEAN SAVERNE

CONTACT US

Tél. +33 (0)3 88 71 53 10

E-mail : commercial@zwiebel.fr

www.zwiebel-weights.com

